

/
COMPANY

—
PROFILE

/







/ STRUCTURE

10,000 sq. m
TOTAL
(7,000 sq. m
COVERED)

5,000
CUSTOMERS

/ TURNOVER

80%
OEM/INDUSTRY

/ PRODUCTION

7,000,000
SINGLE AND
COMBINATION SOCKET
WRENCHES/YEAR

700,000 TOOL
KITS/YEAR

20%
RESALE

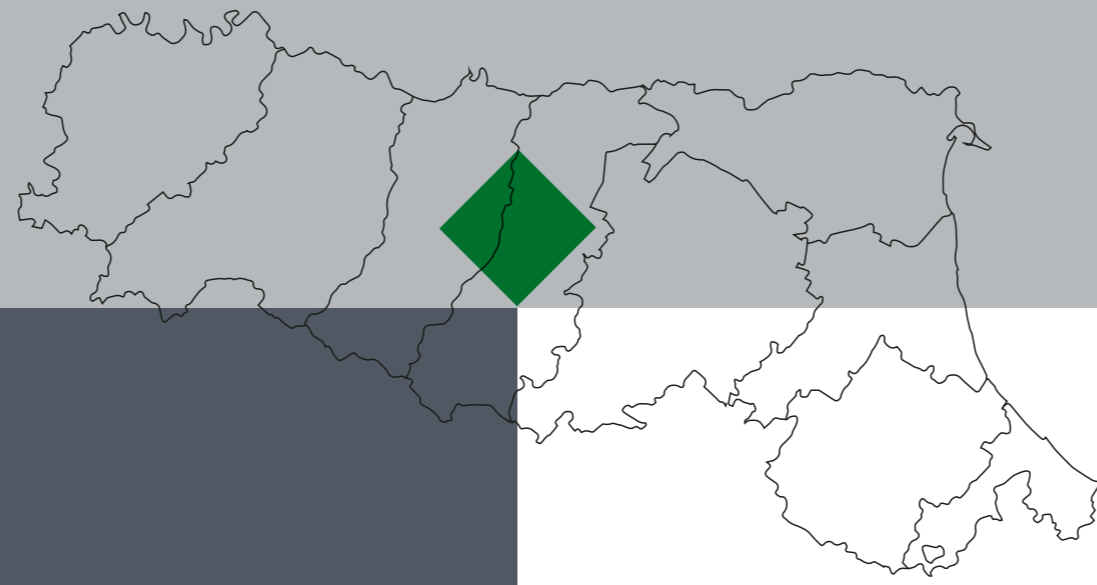
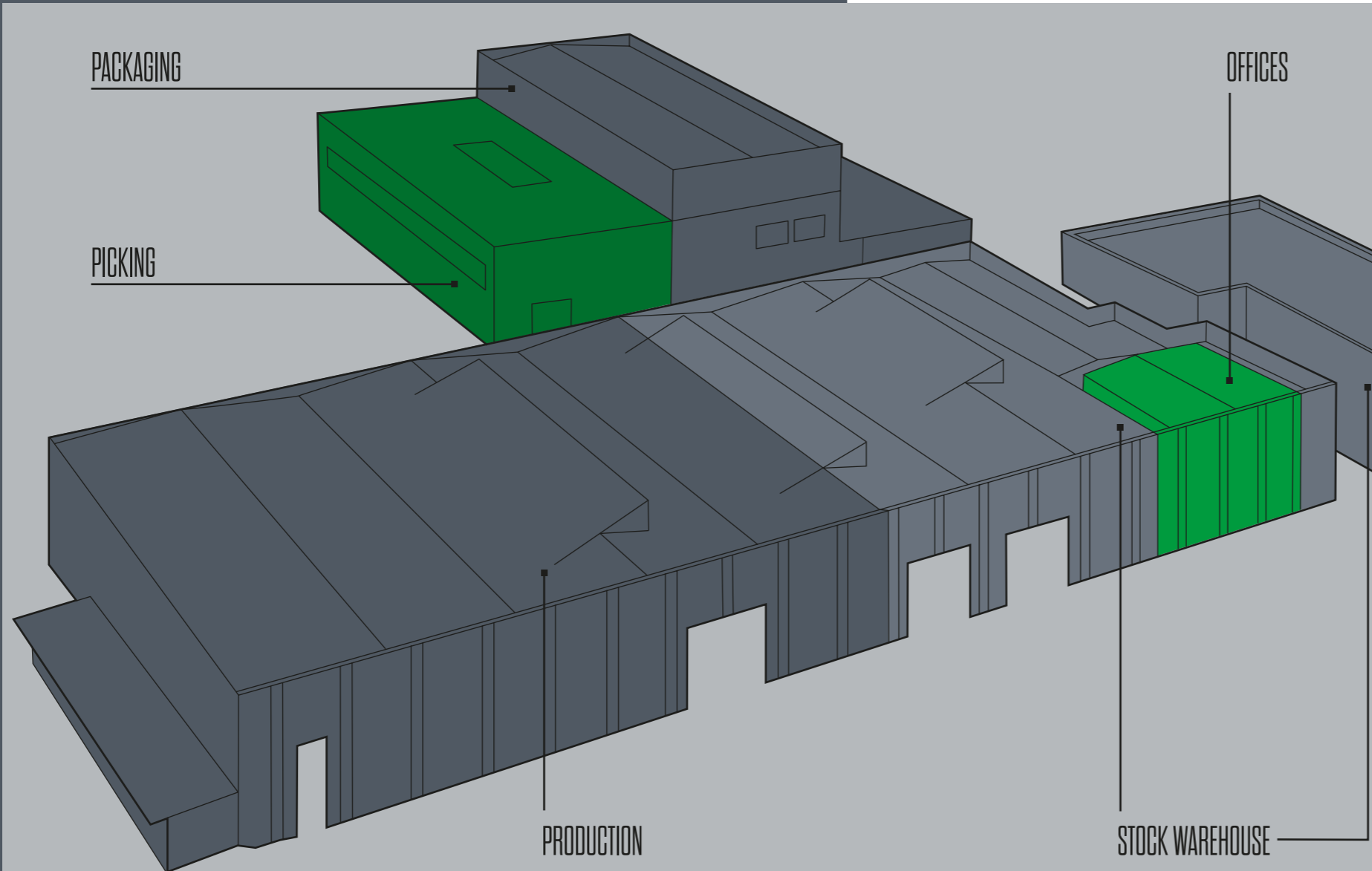

COMPANY

Ferval is a well-known and esteemed company that since 1977 has been designing, producing and trading hand tools and outfit tool kits for the OEM market together with high quality professional hand tools for industry and the after market.

As well as in the production of standard hand tools, Ferval has always been considered a leader in the field of hand tools made to customer design.

The company premises and areas cover 10,000 sq. m and were designed in order to benefit from maximum functionality. All the various stages in the production process are carried out in house, including the study, manufacturing assembly, testing and shipment of all products.

SINGLE AND COMBINATION SOCKET WRENCHES

Ferval's products are made entirely in-house with totally automated and technologically advanced systems. Single/Double tubular wrenches and combination socket wrenches for removing spark plugs, for gardening, agricultural and motorcycling applications are one concrete example.

Ferval is able to produce 7 million combination socket wrenches with 7 robotic welding workstations.

[7 ROBOTIC WELDING WORKSTATIONS]

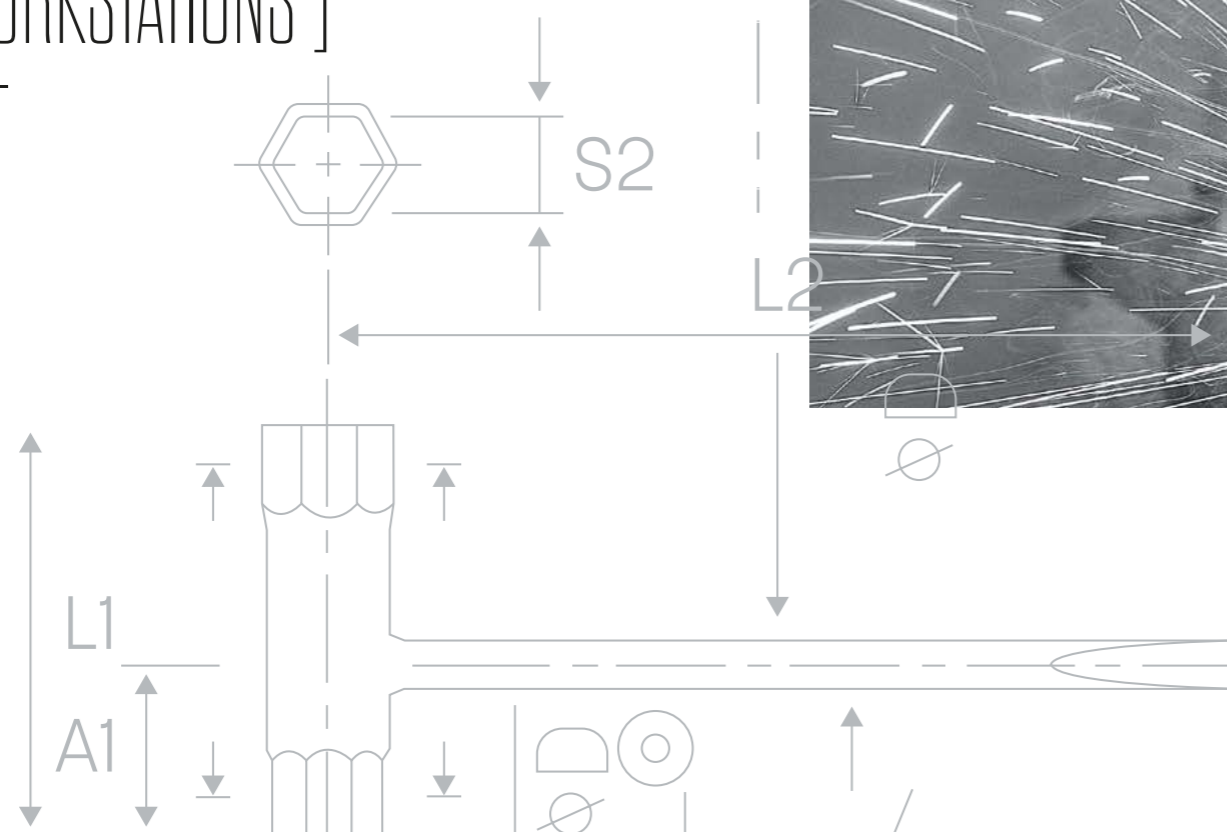

MADE IN ITALY

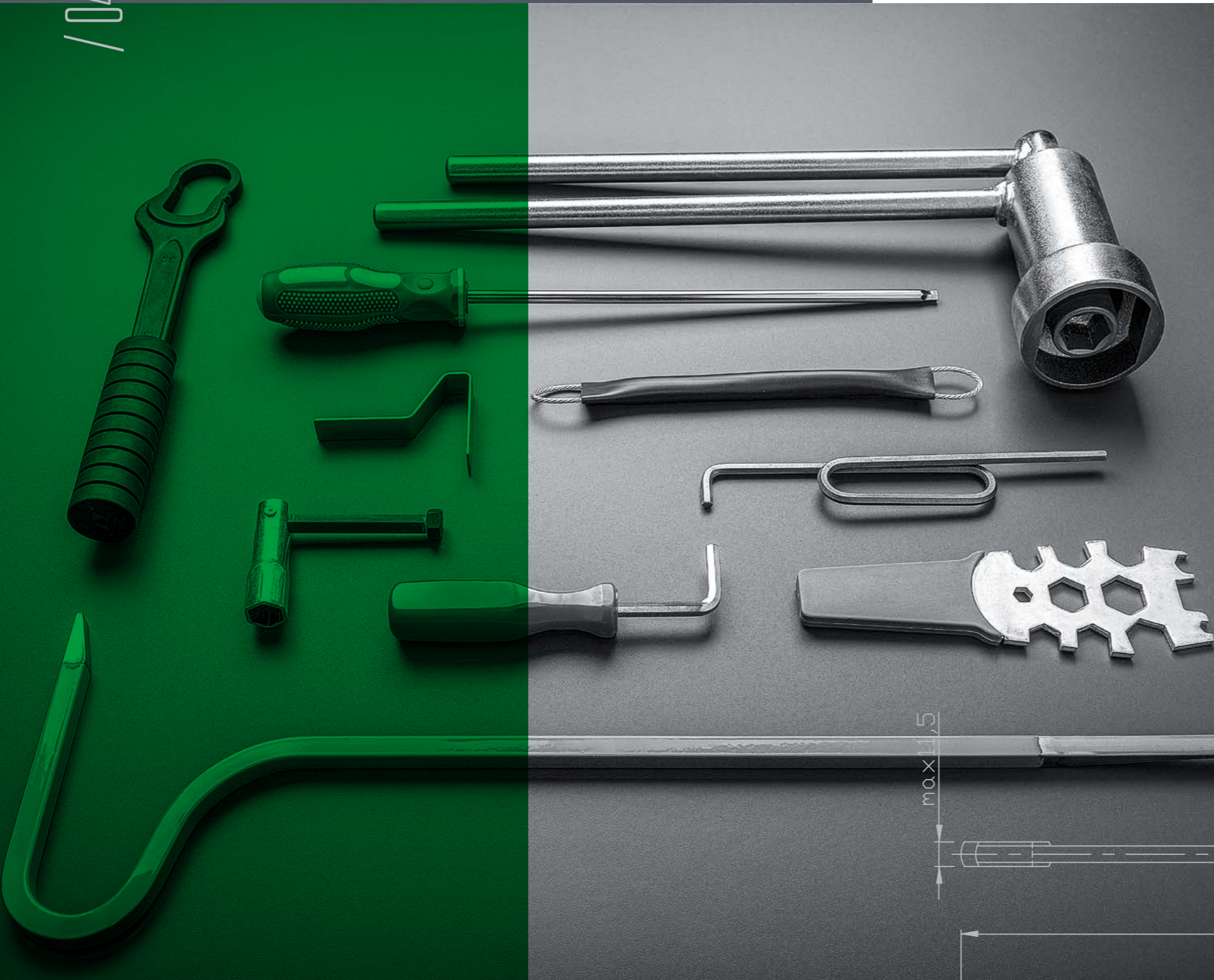

STANDARD AND SPECIAL MANUAL TOOLS

As well as production of standard hand tools, Ferval has always been considered a leader in the field of hand tools made to customer design.

Ferval can offer the right tool for every individual production demand when companies cannot find what they need in the classic range of standard tools.

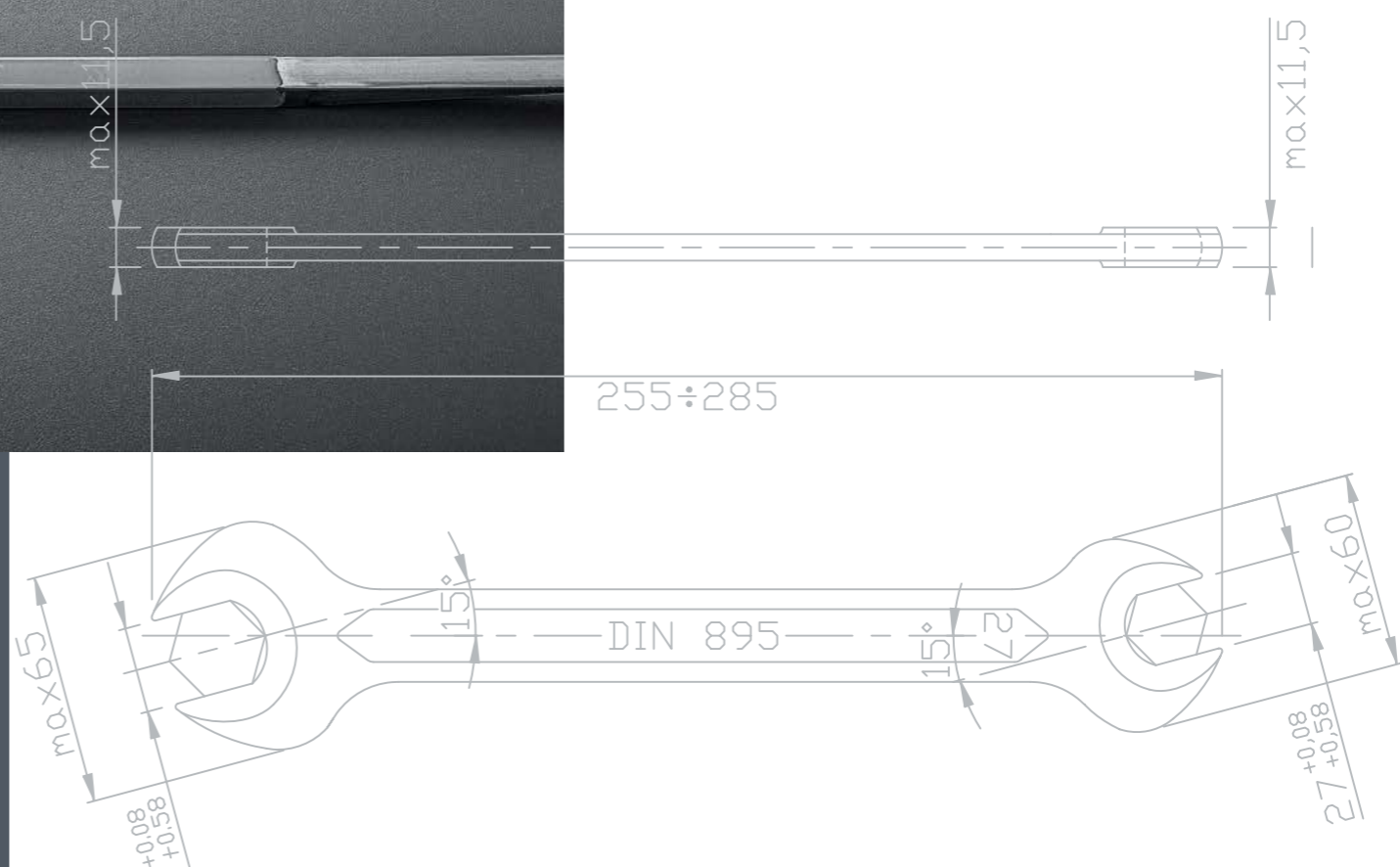

FLEXIBILITY

CUSTOMISED TOOL KITS

With 700,000 kits/year, Ferval is leader in the manufacture of tool kits for industry, and it can offer endless possibilities for product customisation, including:

- Possibility to choose between different quality levels based on customer requirements;
- Branding and marking on the tool;
- Branding of the tool case with company logo and colours;
- Assortment of kits customised for specific fields;
- Customisation of the type of tool case with a choice of different models and materials.

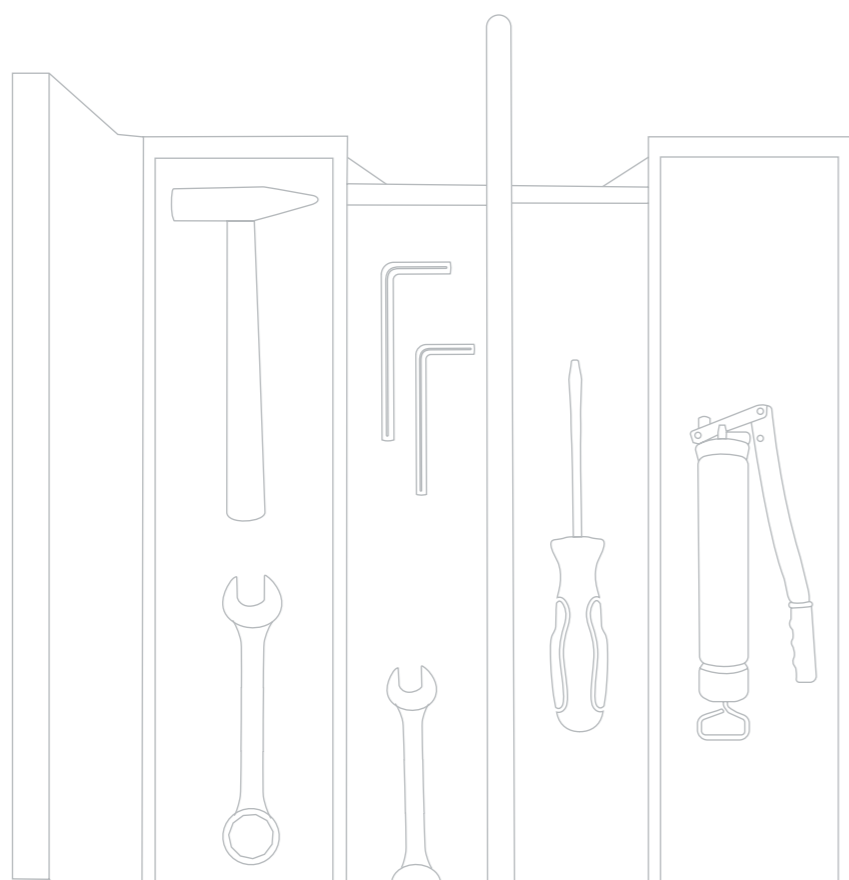

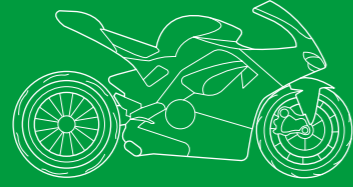

MOTORBIKES

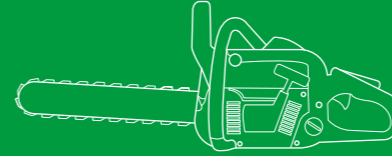
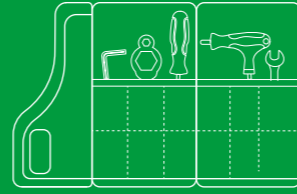

CHAINSAWS AND GARDENING

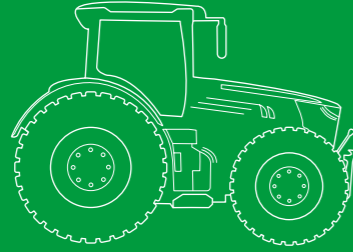
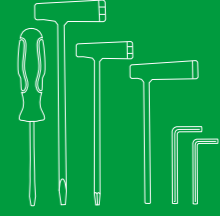

TRACTORS

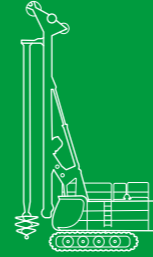
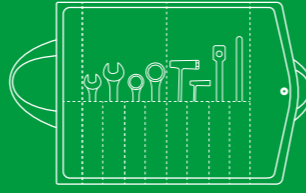

DRILLS

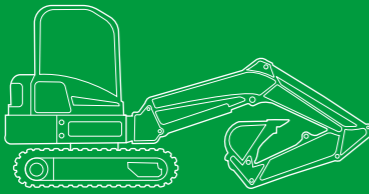
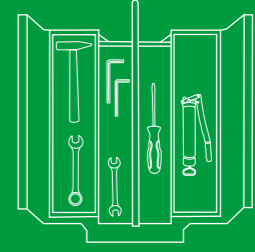

EARTHMOVING MACHINERY

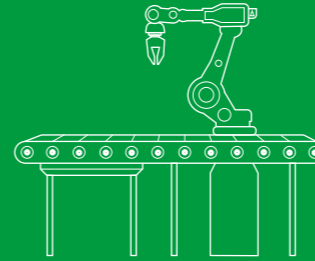
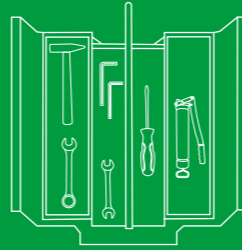

SYSTEMS

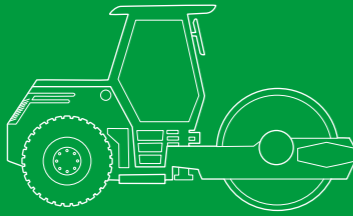
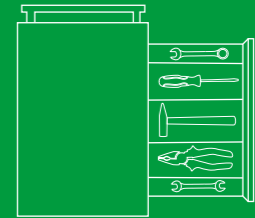

COMPACTORS

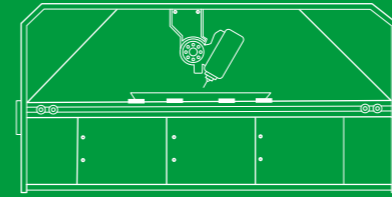
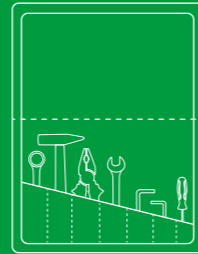

INDUSTRIAL MACHINERY

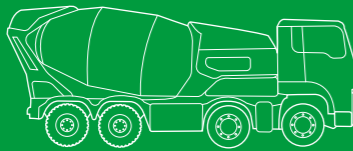
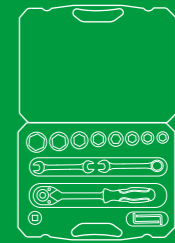

BUILDING MACHINERY

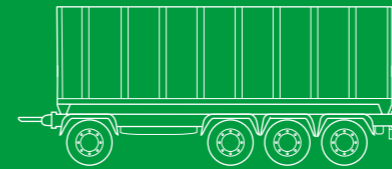
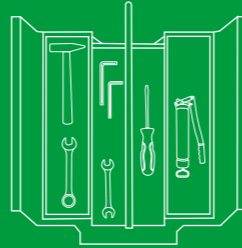

TRAILERS

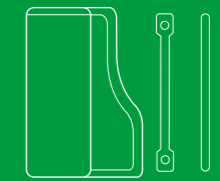

GYM MACHINERY

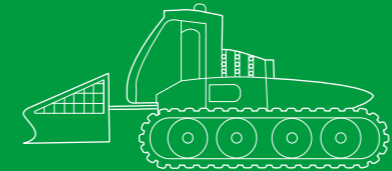

SNOWMOBILES

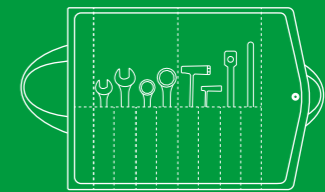

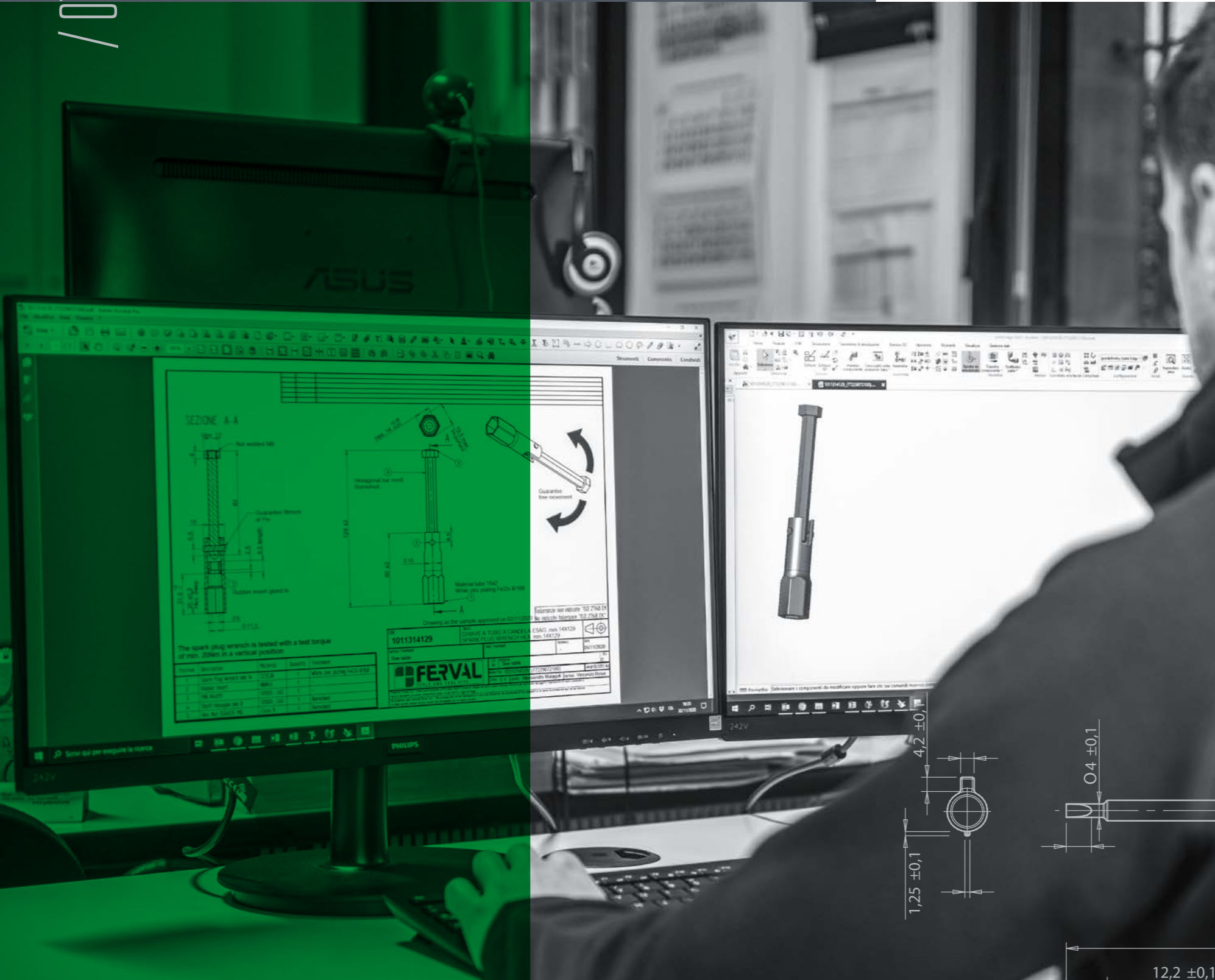

IN-HOUSE DESIGN

Ferval engineers are specialised in developing innovative solutions for every request.

By using the Solid Edge 3D software, Ferval always guarantees all its customers technical support, and high technical expertise allows Ferval to guide and advise customers on their specific needs.

[SOLID EDGE 3D]

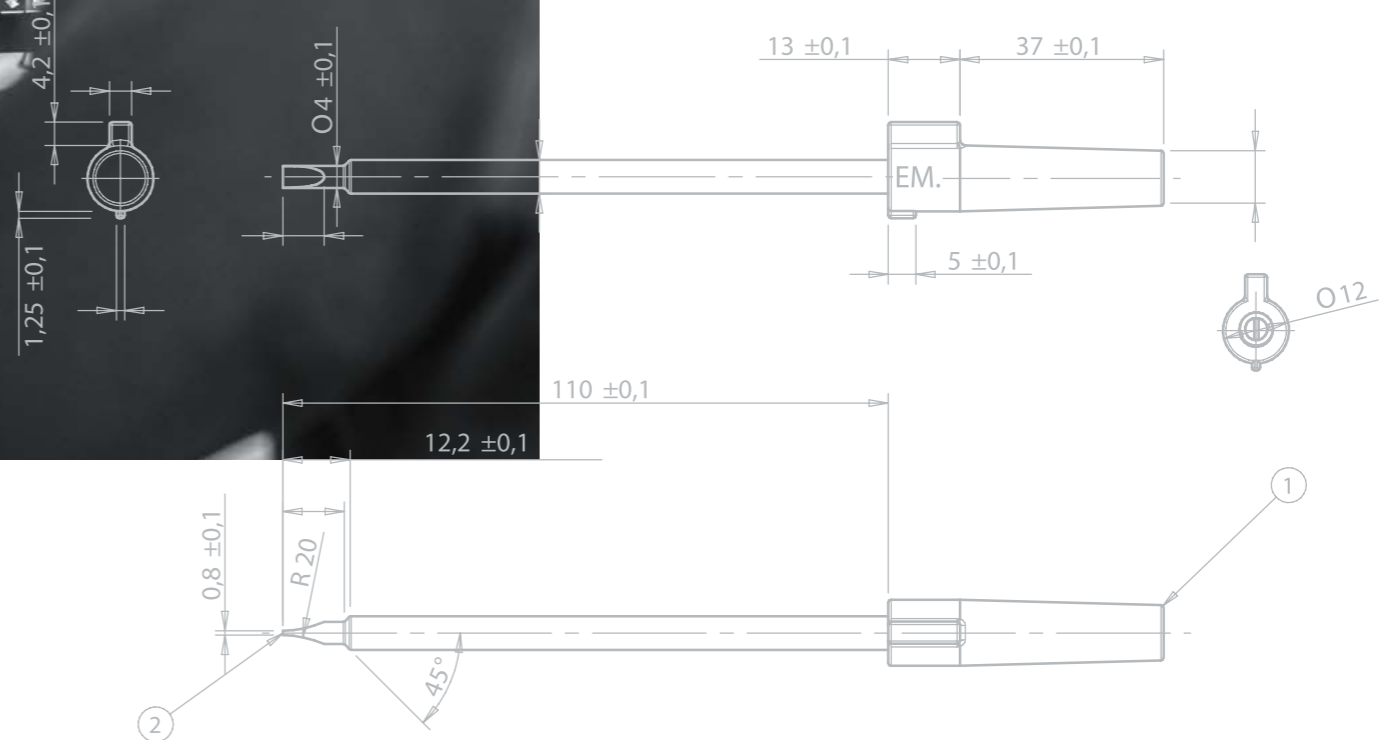

SPECIAL SOLUTIONS

QUALITY CONTROL

An efficient "Technical & Quality" department tests products and carries out strict quality control. Ferval products combine expert technical know-how, high manufacturing technology and certified quality (UNI EN ISO 9001:2015).

Ferval has a network of specialised suppliers and the special attention it pays during selection of raw materials is proof of priority to achieve increasingly safe and reliable products.

Ferval periodically renews the certification to guarantee quality products with appropriate procedures and processes.

[UNI EN ISO 9001:2015]





LOGISTICS

The Ferval logistics system boasts over 40 years of experience and it has been recently upgraded and renewed in an Industry 4.0 perspective.

A structured, always well-stocked and organised warehouse allows Ferval to be extremely efficient, timely, quick and reliable in deliveries.

SHIPPING

Efficient and timely delivery from Ferval's well-stocked warehouse in Reggio Emilia (RE) Italy is always the goal.

TOPTUL

FERVAL is the exclusive distributor of the TOPTUL brand for the Italian market. This line of tools is of top-quality and is warranted for life for requirements of professional users.

- Made in Taiwan
- Warranted professional quality
- High standards and performance
- Wide product range
- Over 3,000 products introduced to the catalogue
- General distributors for Italy

TOPTUL[®]
THE MARK OF PROFESSIONAL TOOLS



KLASS

Line of KLASS-brand DIY products, ideal for do-it-yourselfers and craftspeople, but also suitable for the needs of more expert users

- Proprietary trademark
- Marketing, communication and packaging studied in-house by Ferval's graphics department
- Hardware sector, wholesalers, DIY stores

KLASS



VALUES

SOUNDNESS

Italian company with over 40 years of experience in the manual tools area, both in Italy and abroad.

INNOVATION

Fast and timely deliveries from our extensive and well-stocked warehouse set up in an Industry 4.0 perspective.

FLEXIBILITY

Development of special manual tools to the customer's design to meet specific production requirements.

CUSTOMISATION

Special solutions, infinite possibilities for kit and tool customisation with company logos and colours.

RELIABILITY

Advanced "Technical & Quality" department, selected suppliers, UNI EN ISO 9001:2015 quality certification.

CONFIDENCE

Tools and kits known and constantly adopted by leading companies of many fields.



ART DIRECTION + PHOTOS + GRAPHICS > FLUSHDESIGN.IT
PRINTING > ESPERANTINI
© FERVAL SRL

